





NR:	Montering av karm type SD2 - en fløyet dør
1	Sjekk murmål mot pakkseddel/ordre.
2	Monter karm i vegg med skrue og plugg A
	Bruk terskelen for å justere bredde til karm i underkant.
	(NB: bare på dører hvor terskel leveres. Ekstraustyr)
3	Terskel festes med skrue og plugg A. Ekstraustyr.
4	Isoler mellom vegg og karm.
5	Karm fuges utvendig etter innsetting.

				
A	Ø13+Ø8	x8 eller x10	x8 eller x10	x8 eller x10

1

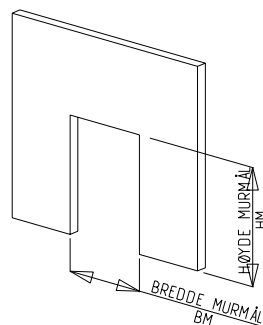

KIAS

D Ø R E N

Montering av
karm type SD2-E

2

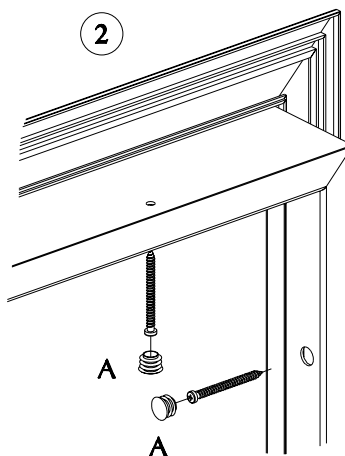

2

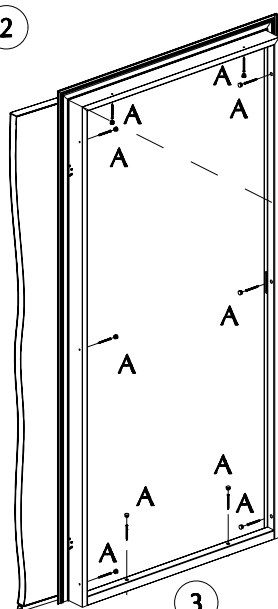

3

5

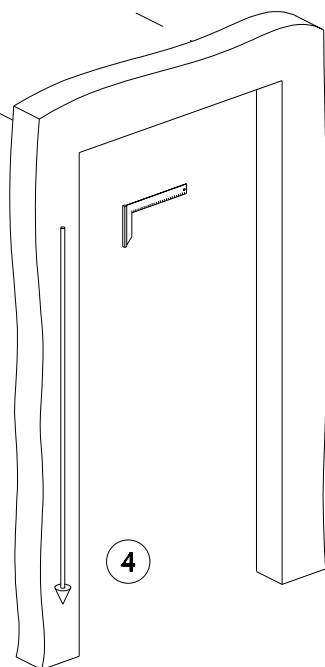

4